

The rechargeable batteries are lead-lead dioxide systems. The dilute sulfuric acid electrolyte is absorbed by separators and plates and thus immobilized. Should the battery be accidentally overcharged producing hydrogen and oxygen, special one-way valves allow the gases to escape thus avoiding excessive pressure build-up. Otherwise, the battery is completely sealed and is, therefore, maintenance-free, leak proof and usable in any position.



Battery Construction

Component	Positive plate	Negative plate	Container	Cover	Safety valve	Terminal	Separator	Electrolyte
Raw material	Lead dioxide	Lead	ABS	ABS	Rubber	Copper	Fiberglass	Sulfuric acid

General Feature

- Absorbent Glass Mat(AGM) technology for efficient gas recombination of up to 99% and freedom from electrolyte maintenance or water adding.
- Not restricted for air transport-complies with IATA/ICAO Special Provision A67.
- UL-recognized component.
- Can be mounted in any orientation.
- Computer designed lead, calcium tin alloy grid for high power density.
- Long service life, float or cyclic applications.
- Maintenance-free operation.
- Low self discharge.

Performance Characteristics

Capacity 77°F(25°C)	20 hour rate (7.0A、10.8V)	140Ah
	10 hour rate (13.4A、10.8V)	134Ah
	5 hour rate (24.2A、10.5V)	121Ah
	1 hour rate (92A、9.6V)	92Ah
Internal Resistance	Full charged Battery77°F(25°C): 4mΩ	
Capacity affected by Temperature (10 hour rate)	104° F(40°C)	102%
	77° F(25°C)	100%
	32° F(10°C)	85%
	5° F(-15°C)	65%
Self-Discharge 68°F(20°C)	Capacity after 3 month storage	90%
	Capacity after 6 month storage	80%
	Capacity after 12month storage	60%
Max. discharge current77°F(25°C): 1000A(5S)		
Charge (Constant Voltage)	Float: 13.6~13.8 V/77° F(25°C)	
	Cycle:14.4~14.7 V/77°F(25°C) Max. Current: 33.5A	

SPECIFICATION

Nominal voltage 12V
 Number of cell 6
 Length(mm/inch) 341/13.4
 Width(mm/inch) 173/6.81
 Height(mm/inch) 283/11.1
 Total Height(mm/inch) 288/11.3
 Approx. Weight(kg/lbs) 40/88.2

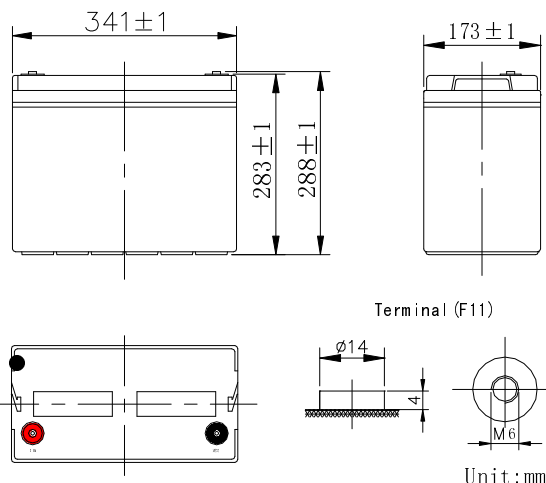

Discharge Constant Current (Amperes at 77° F 25 °C)

End Point Volts/Cell	5min	10min	15min	30min	1h	3h	5h	10h	20h
1.60V	440	310	245	152	92.0	39.5	25.3	13.8	7.20
1.65V	423	297	236	147	89.0	38.6	25.0	13.8	7.20
1.70V	404	283	226	142	85.5	37.5	24.6	13.7	7.15
1.75V	383	267	216	136	82.0	36.4	24.2	13.6	7.10
1.80V	361	249	205	129	78.0	35.2	23.7	13.4	7.00

Discharge Constant Power (watts at 77° F 25 °C)

End Point Volts/Cell	5min	10min	15min	30min	45min	1h	2h	3h	5h
1.60V	760	550	480	285	217	175	103	72.0	51.0
1.65V	730	525	460	273	209	170	100	70.5	50.2
1.70V	697	498	439	259	200	164	96.5	68.8	49.3
1.75V	660	468	417	245	191	158	93.0	67.0	48.3
1.80V	620	435	393	230	181	151	89.0	65.0	47.1

(Note)The above characteristics data are average values obtained Within three charge/discharge cycles not the minimum values.

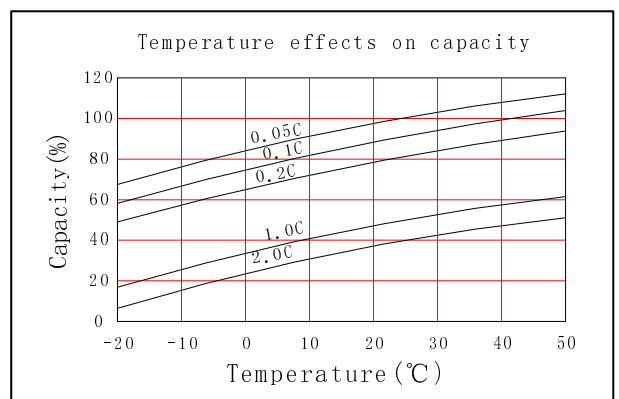
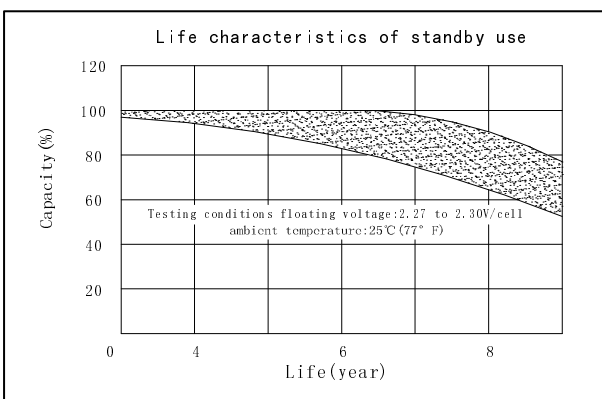
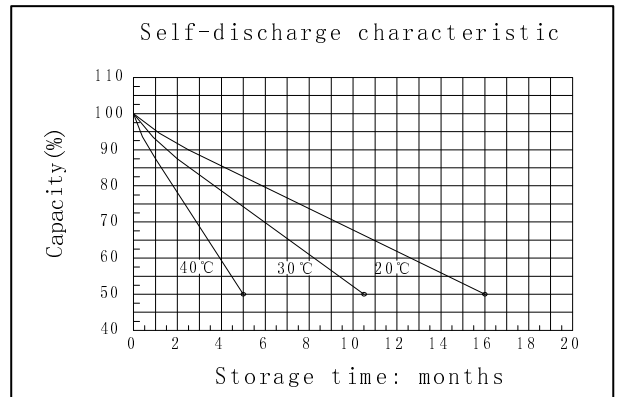
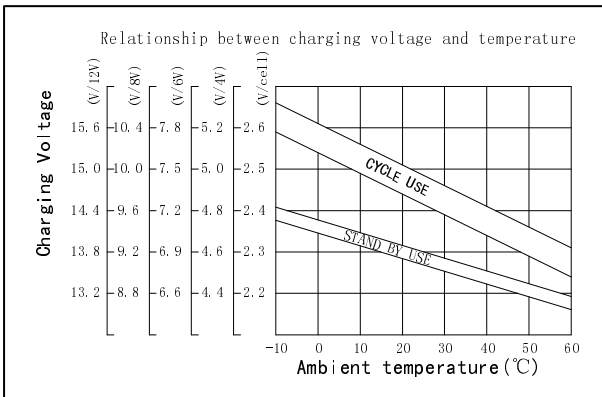
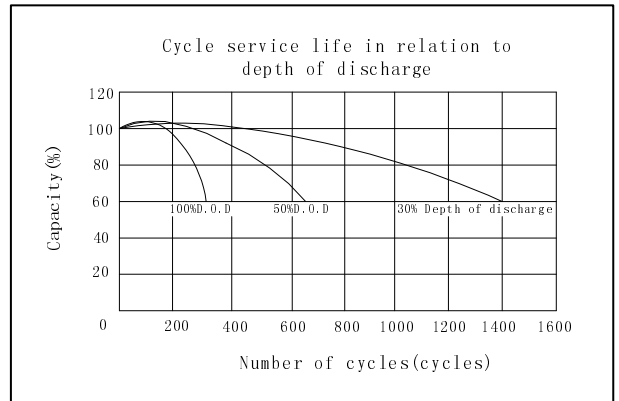
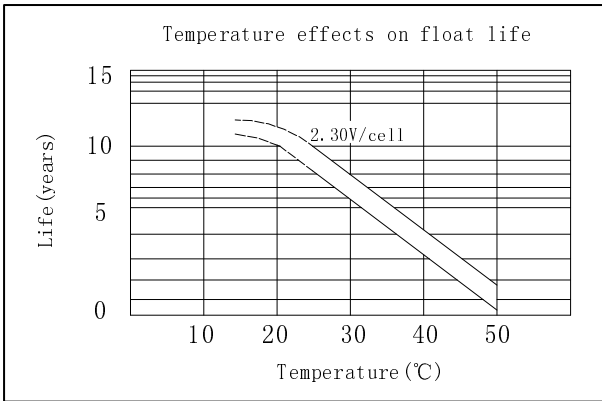
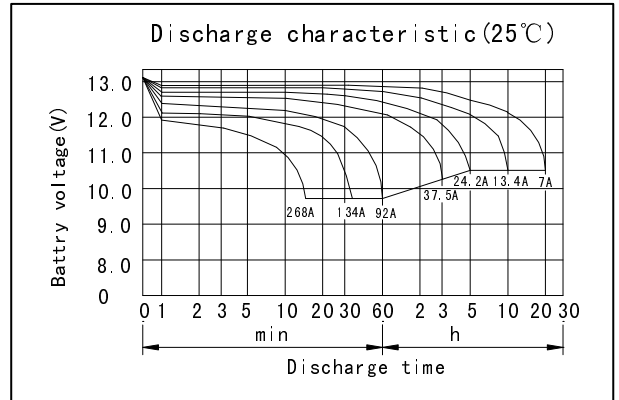
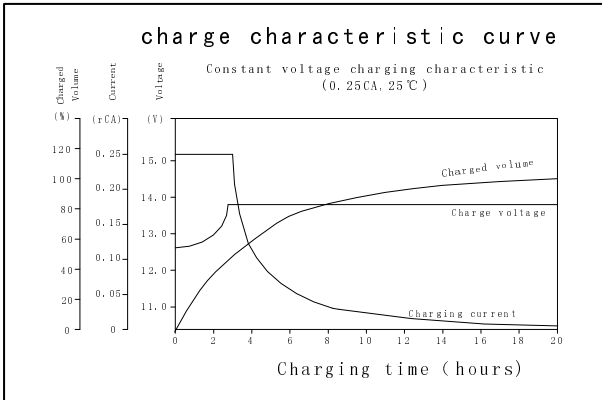

GREAT POWER BATTERY TECHNOLOGY CO.,LTD

Address: Longguan 1st Road, LongHua Town, BaoAn District, Shenzhen, China.

TEL: 86-755-2900 8403 Fax: 86-755-3386 3366

Email: info@greatpowerbattery.com Http:// www.greatpowerbattery.com

