

The rechargeable batteries are lead-lead dioxide systems. The dilute sulfuric acid electrolyte is absorbed by separators and plates and thus immobilized. Should the battery be accidentally overcharged producing hydrogen and oxygen, special one-way valves allow the gases to escape thus avoiding excessive pressure build-up. Otherwise, the battery is completely sealed and is, therefore, maintenance-free, leak proof and usable in any position.



Battery Construction

Component	Positive plate	Negative plate	Container	Cover	Safety valve	Terminal	Separator	Electrolyte
Raw material	Lead dioxide	Lead	ABS	ABS	Rubber	Copper	Fiberglass	Sulfuric acid

General Feature

- Absorbent Glass Mat(AGM) technology for efficient gas recombination of up to 99% and freedom from electrolyte maintenance or water adding.
- Not restricted for air transport-complies with IATA/ICAO Special Provision A67.
- UL-recognized component.
- Can be mounted in any orientation.
- Computer designed lead, calcium tin alloy grid for high power density.
- Long service life, float or cyclic applications.
- Maintenance-free operation.
- Low self discharge.

Performance Characteristics

Capacity 77°F(25°C)	20 hour rate (7.8A、10.8V)	156Ah
	10 hour rate (15A、10.8V)	150Ah
	5 hour rate (26.6A、10.5V)	133Ah
	1 hour rate (97A、9.6V)	97Ah
Internal Resistance	Full charged Battery77°F(25°C): 4mΩ	
Capacity affected by Temperature (20 hour rate)	104° F(40°C)	102%
	77° F(25°C)	100%
	32° F(10°C)	85%
	5° F(-15°C)	65%
Self-Discharge 68°F(20°C)	Capacity after 3 month storage	90%
	Capacity after 6 month storage	80%
	Capacity after 12month storage	60%
Max. discharge current77°F(25°C): 950A(5S)		
Charge (Constant Voltage)	Float: 13.6~13.8 V/77° F(25°C)	
	Cycle:14.4~14.7 V/77°F(25°C) Max. Current: 37.5A	

SPECIFICATION

Nominal voltage 12V
 Number of cell 6
 Length(mm/inch) 482/19.0
 Width(mm/inch) 170/6.69
 Height(mm/inch) 242/9.53
 Total Height(mm/inch) 242/9.53
 Approx. Weight(kg/lbs) 45/99.2

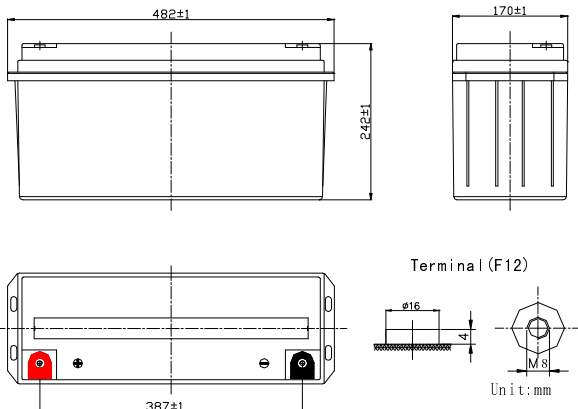

Discharge Constant Current (Amperes at 77°F25°C)

End Point Volts/Cell	5min	10min	15min	30min	1h	3h	5h	10h	20h
1.60V	445	347	282	163	97.0	40.1	28.1	15.5	7.93
1.65V	415	327	267	158	95.0	39.4	27.6	15.4	7.90
1.70V	384	306	253	153	93.0	38.5	27.1	15.3	7.90
1.75V	352	286	239	147	91.0	38.0	26.6	15.2	7.85
1.80V	317	263	226	144	89.0	37.4	26.0	15.0	7.80

Discharge Constant Power (watts at 77° F 25 °C)

End Point Volts/Cell	5min	10min	15min	30min	45min	1h	2h	3h	5h
1.60V	765	609	501	325	221	201	112	78.0	53.5
1.65V	734	579	483	315	216	198	110	77.1	53.2
1.70V	686	548	465	306	211	195	108	76.2	52.8
1.75V	638	519	446	296	206	190	106	75.3	52.5
1.80V	591	487	425	286	202	184	105	74.0	52.0

(Note)The above characteristics data are average values obtained Within three charge/discharge cycles not the minimum values.

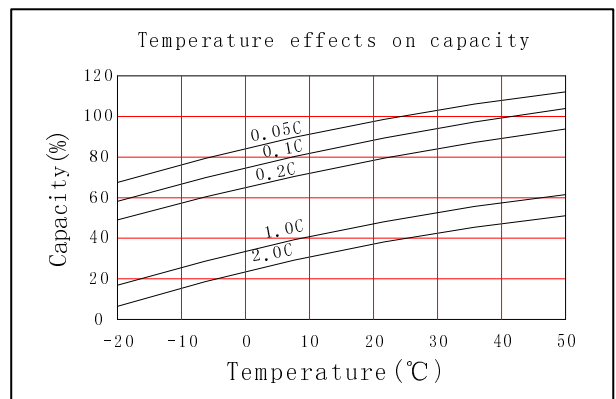
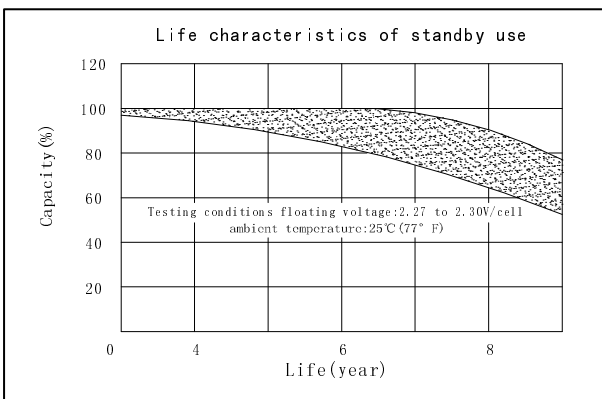
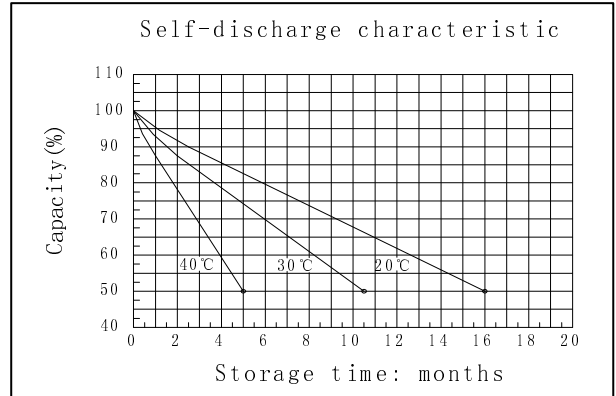
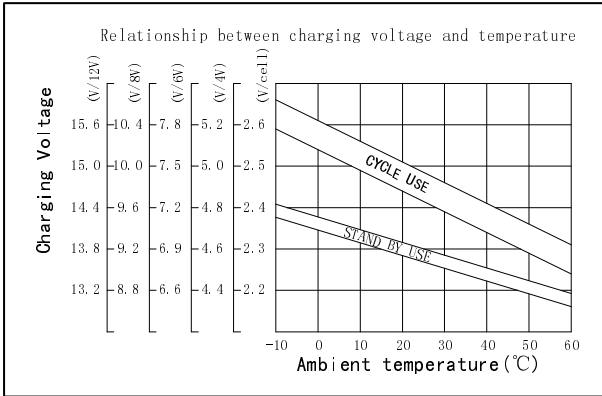
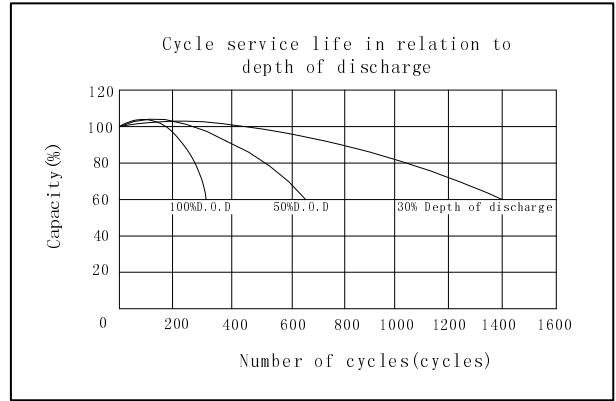
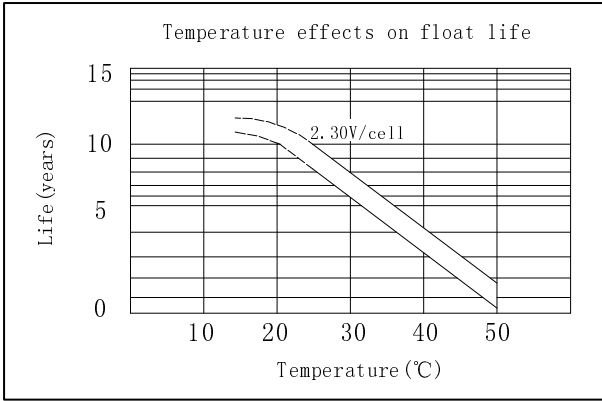
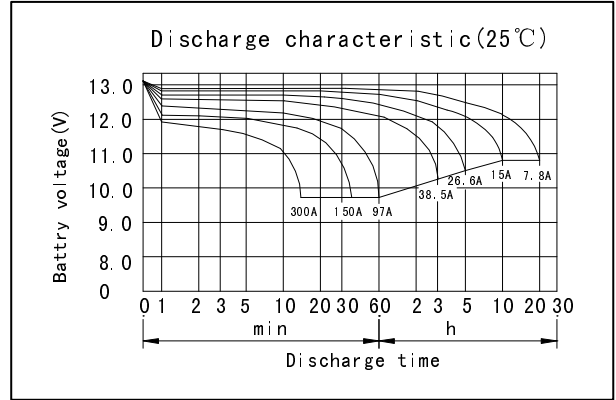
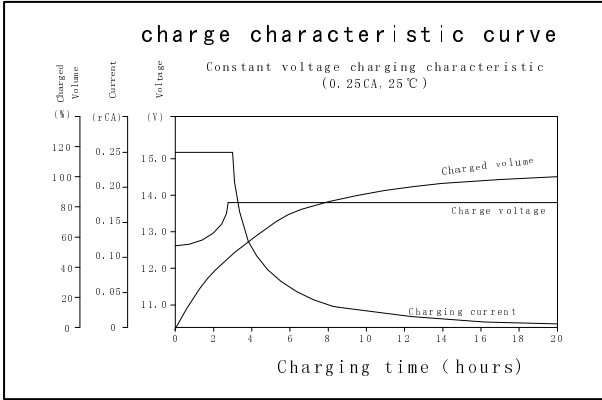

GREAT POWER BATTERY TECHNOLOGY CO.,LTD
 Address: Longguan 1st Road, Longhua Town, BaoAn District, Shenzhen, China.
 TEL: 86-755-2900 8403 Fax: 86-755-3386 3366
 Email: info@greatpowerbattery.com Http:// www.greatpowerbattery.com