

The rechargeable batteries are lead-lead dioxide systems. The dilute sulfuric acid electrolyte is absorbed by separators and plates and thus immobilized. Should the battery be accidentally overcharged producing hydrogen and oxygen, special oneway valves allow the gases to escape thus avoiding excessive pressure build-up. Otherwise, the battery is completely sealed and is, therefore, maintenance-free, leak proof and usable in any position.



Battery Construction

Component	Positive plate	Negative plate	Container	Cover	Safety valve	Terminal	Separator	Electrolyte
Raw material	Lead dioxide	Lead	ABS	ABS	Rubber	Copper	Fiberglass	Sulfuric acid

General Feature

- Absorbent Glass Mat(AGM) technology for efficient gas recombination of up to 99% and freedom from electrolyte maintenance or water adding.
- Not restricted for air transport-complies with IATA/ICAO Special Provision A67.
- UL-recognized component.
- Can be mounted in any orientation.
- Computer designed lead, calcium tin alloy grid for high power density.
- Long service life, float or cyclic applications.
- Maintenance-free operation.
- Low self discharge.

Performance Characteristics

Capacity 77°F(25°C)	10 hour rate (15A、1.80V)	150Ah
	5 hour rate (26.6A、1.75V)	133Ah
	3 hour rate (38A、1.70V)	114Ah
	1 hour rate (95A、1.60V)	95Ah
Internal Resistance	Full charged Battery77°F(25°C): 1mΩ	
Capacity affected by Temperature (10 hour rate)	104° F(40°C)	102%
	77° F(25°C)	100%
	32° F(10°C)	85%
	5° F(-15°C)	65%
Self-Discharge 68°F(20°C)	Capacity after 3 month storage	90%
	Capacity after 6 month storage	80%
	Capacity after 12month storage	60%
Max. discharge current77°F(25°C): 750A(5S)		
Charge (Constant Voltage)	Float: 2.25~2.30 V/77° F(25°C)	
	Cycle:2.35~2.45 V/77°F(25°C) Max. Current: 30A	

SPECIFICATION

Nominal voltage 2V
 Number of cell 1
 Length(mm/inch) 171/6.73
 Width(mm/inch) 102/4.02
 Height(mm/inch) 206/8.11
 Total Height(mm/inch) 221/8.70
 Approx. Weight(kg/lbs) 8.0/17.6

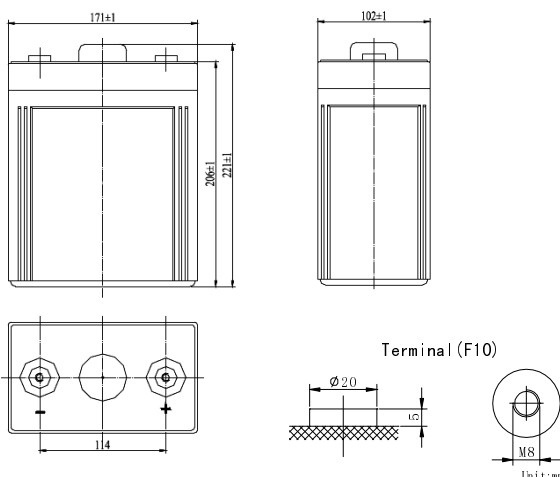

Discharge Constant Current (Amperes at 77° F 25 °C)

End Point Volts/Cell	5min	10min	15min	30min	45min	1h	3h	5h	10h
1.60V		290	218	145	119	95.0	40.7	28.7	15.8
1.65V		275	207	139	114	92.8	39.2	28.2	15.6
1.70V		260	196	132	109	89.0	38.0	27.4	15.4
1.75V		243	185	125	104	85.0	37.0	26.6	15.2
1.80V		225	174	118	98	81.0	35.0	25.5	15.0

Discharge Constant Power (watts at 77° F 25 °C)

End Point Volts/Cell	5min	10min	15min	30min	45min	1h	2h	3h	5h
1.60V		420	381	290	218	182	117	79.3	58.0
1.65V		396	360	275	207	174	113	77.4	57.0
1.70V		371	339	260	197	166	109	75.3	56.0
1.75V		346	318	245	186	158	105	73.0	55.0
1.80V		321	296	229	175	149	100	70.5	53.8

(Note)The above characteristics data are average values obtained Within three charge/discharge cycles not the minimum values.

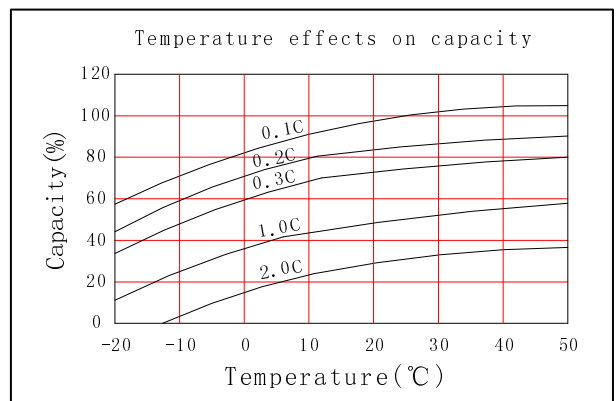
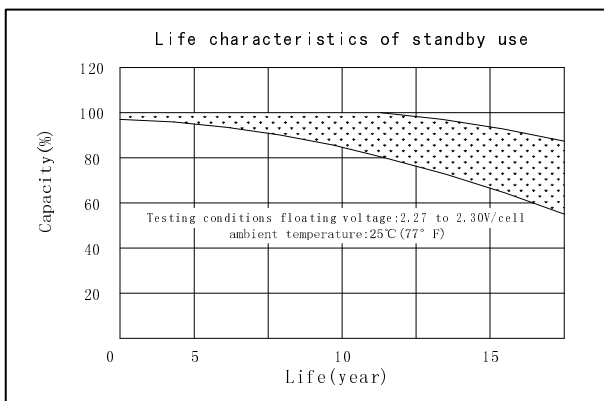
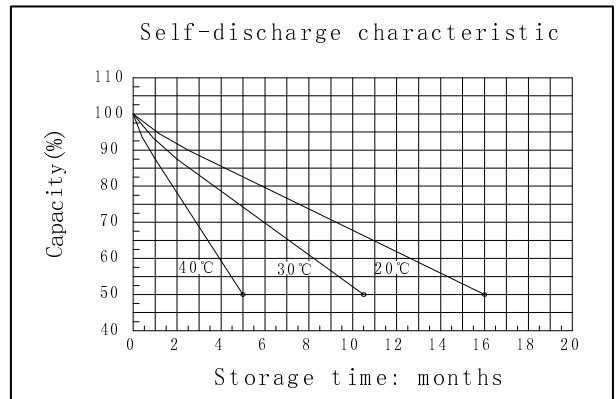
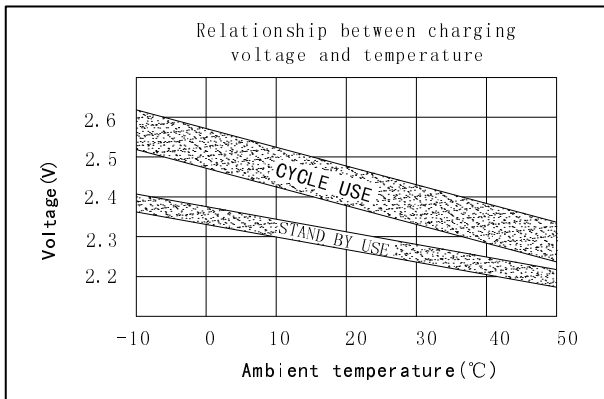
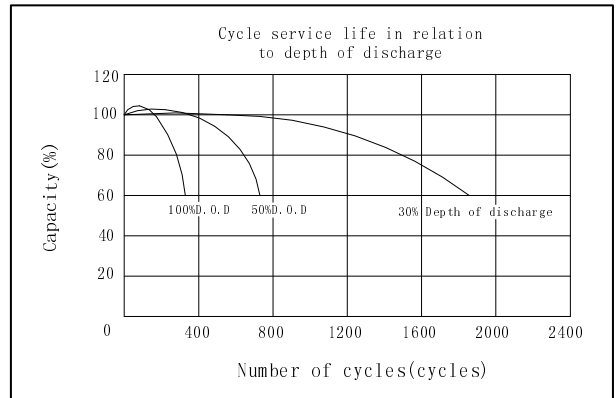
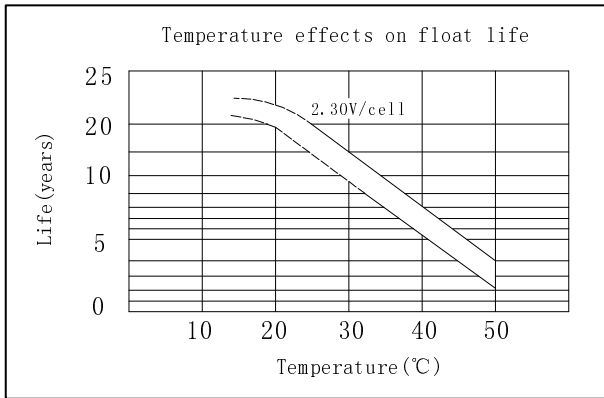
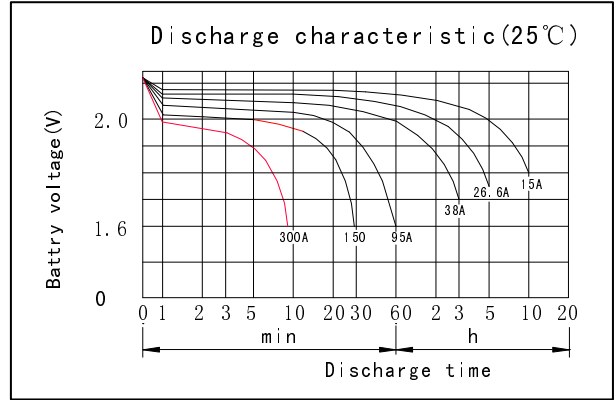
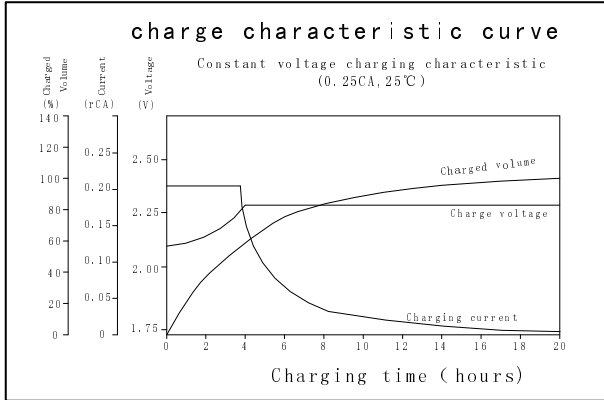

GREAT POWER BATTERY TECHNOLOGY CO.,LTD
 Address: Longguan 1st Road, LongHua Town, BaoAn District, Shenzhen, China.
 TEL: 86-755-2900 8403 Fax: 86-755-3386 3366
 Email: info@greatpowerbattery.com Http:// www.greatpowerbattery.com