

The rechargeable batteries are lead-lead dioxide systems. The dilute sulfuric acid electrolyte is absorbed by separators and plates and thus immobilized. Should the battery be accidentally overcharged producing hydrogen and oxygen, special oneway valves allow the gases to escape thus avoiding excessive pressure build-up. Otherwise, the battery is completely sealed and is, therefore, maintenance-free, leak proof and usable in any position.



### Battery Construction

Component	Positive plate	Negative plate	Container	Cover	Safety valve	Terminal	Separator	Electrolyte
Raw material	Lead dioxide	Lead	ABS	ABS	Rubber	Copper	Fiberglass	Sulfuric acid

### General Feature

- Absorbent Glass Mat(AGM) technology for efficient gas recombination of up to 99% and freedom from electrolyte maintenance or water adding.
- Not restricted for air transport-complies with IATA/ICAO Special Provision A67.
- UL-recognized component.
- Can be mounted in any orientation.
- Computer designed lead, calcium tin alloy grid for high power density.
- Long service life, float or cyclic applications.
- Maintenance-free operation.
- Low self discharge.

### Performance Characteristics

Capacity 77°F(25°C)	10 hour rate (60A、1.80V)	600Ah
	5 hour rate (106A、1.75V)	530Ah
	3 hour rate (170A、1.70V)	510Ah
	1 hour rate (364A、1.60V)	364Ah
Internal Resistance	Full charged Battery77°F(25°C): 0.7mΩ	
Capacity affected by Temperature (10 hour rate)	104° F(40°C)	102%
	77° F(25°C)	100%
	32° F(10°C)	85%
	5° F(-15°C)	65%
Self-Discharge 68°F(20°C)	Capacity after 3 month storage	90%
	Capacity after 6 month storage	80%
	Capacity after 12month storage	60%
Max. discharge current77°F(25°C): 2000A(5S)		
Charge (Constant Voltage)	Float: 2.25~2.30 V/77° F(25°C)	
	Cycle:2.35~2.45 V/77°F(25°C) Max. Current: 120A	

### SPECIFICATION

- Nominal voltage ..... 2V
- Number of cell ..... 1
- Length(mm/inch) ..... 302/11.9
- Width(mm/inch) ..... 175/6.89
- Height(mm/inch) ..... 330/13.0
- Total Height(mm/inch) ..... 367/14.45
- Approx. Weight(kg/lbs) ..... 37/81.5

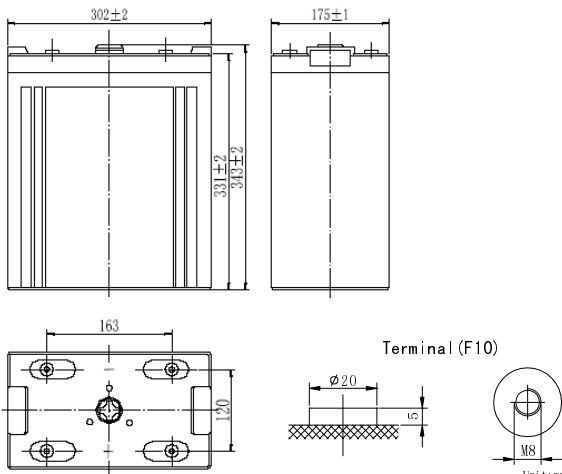

Total height with removable cover:367

#### Discharge Constant Current (Amperes at 77° F25 °C)

End Point Volts/Cell	5min	10min	15min	30min	45min	1h	3h	5h	10h
1.60V		1155	885	616	479	364	180	113	64
1.65V		1095	841	588	460	351	175	111	63
1.70V		1033	797	560	440	337	170	109	62
1.75V		969	752	530	416	322	163	106	61
1.80V		904	707	500	395	307	156	103	60

#### Discharge Constant Power (watts at 77° F 25 °C)

End Point Volts/Cell	5min	10min	15min	30min	45min	1h	2h	3h	5h
1.60V		1911	1424	1123	905	710	483	358	225
1.65V		1800	1347	1067	864	680	472	349	222
1.70V		1688	1269	1009	820	649	460	340	218
1.75V		1577	1191	951	776	617	446	330	214
1.80V		1467	1112	892	731	583	418	309	211

(Note)The above characteristics data are average values obtained Within three charge/discharge cycles not the minimum values.

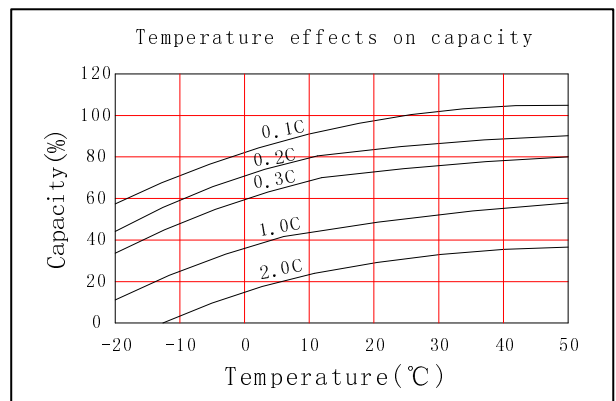
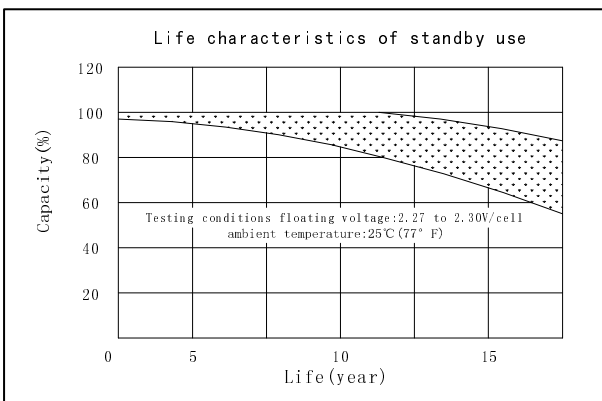
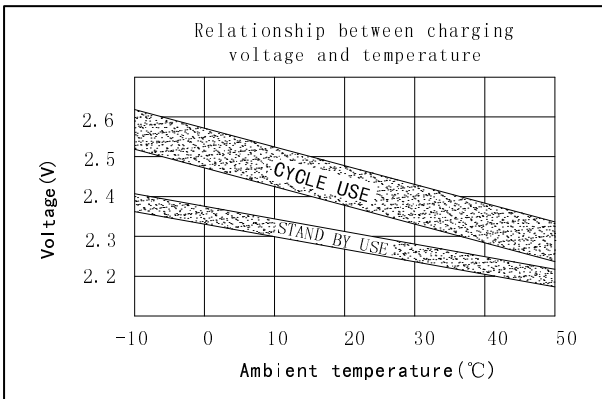
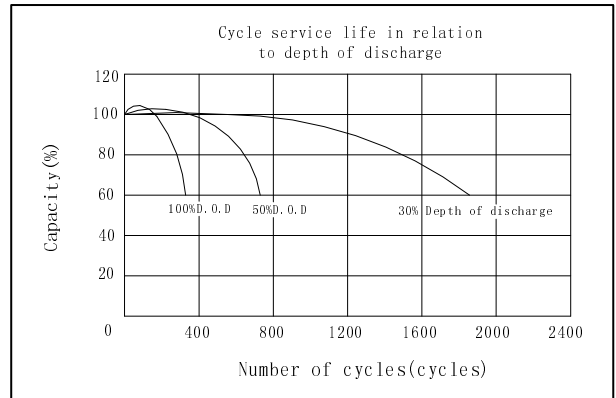
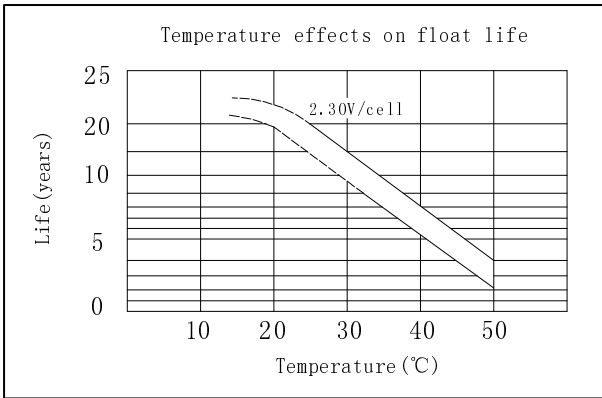
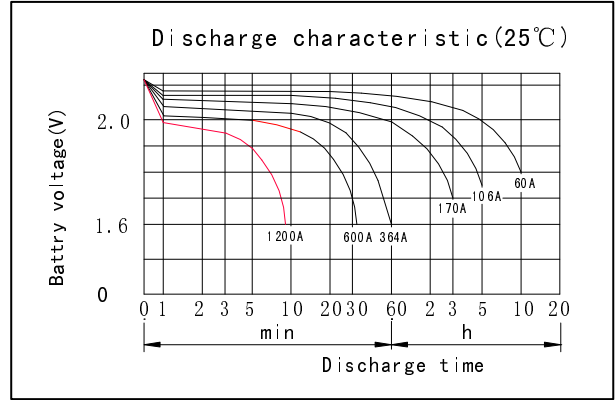
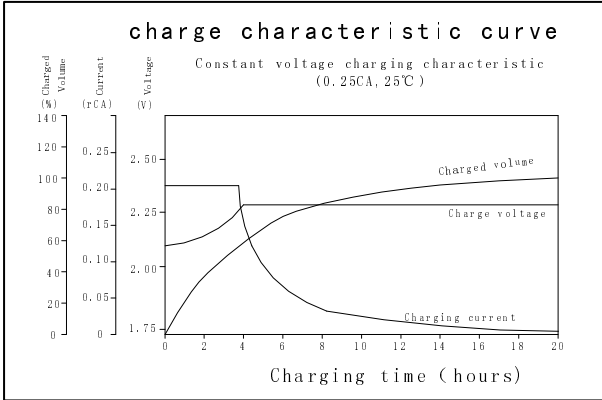

**GREAT POWER BATTERY TECHNOLOGY CO.,LTD**  
 Address: Longguan 1st Road, LongHua Town, BaoAn District, Shenzhen, China.  
 TEL: 86-755-2900 8403 Fax: 86-755-3386 3366  
 Email: info@greatpowerbattery.com Http:// www.greatpowerbattery.com