

The rechargeable batteries are lead-lead dioxide systems. The dilute sulfuric acid electrolyte is absorbed by separators and plates and thus immobilized. Should the battery be accidentally overcharged producing hydrogen and oxygen, special one-way valves allow the gases to escape thus avoiding excessive pressure build-up. Otherwise, the battery is completely sealed and is, therefore, maintenance-free, leak proof and usable in any position.



Battery Construction

Component	Positive plate	Negative plate	Container	Cover	Safety valve	Terminal	Separator	Electrolyte
Raw material	Lead dioxide	Lead	ABS	ABS	Rubber	Copper	Fiberglass	Sulfuric acid

General Feature

- Absorbent Glass Mat(AGM) technology for efficient gas recombination of up to 99% and freedom from electrolyte maintenance or water adding.
- Not restricted for air transport-complies with IATA/ICAO Special Provision A67.
- UL-recognized component.
- Can be mounted in any orientation.
- Computer designed lead, calcium tin alloy grid for high power density.
- Long service life, float or cyclic applications.
- Maintenance-free operation.
- Low self discharge.

Performance Characteristics

Capacity 77°F(25°C)	20 hour rate (5.2A、10.8V)	104Ah
	10 hour rate (10A、10.8V)	100Ah
	5 hour rate (17.4A、10.5V)	87Ah
	1 hour rate (63.5A、9.6V)	63.5Ah
Internal Resistance	Full charged Battery77°F(25°C): 6mΩ	
Capacity affected by Temperature (20 hour rate)	104° F(40°C)	102%
	77° F(25°C)	100%
	32° F(10°C)	85%
	5° F(-15°C)	65%
Self-Discharge 68°F(20°C)	Capacity after 3 month storage	90%
	Capacity after 6 month storage	80%
	Capacity after 12month storage	60%
Max. discharge current77°F(25°C): 800A(5S)		
Charge (Constant Voltage)	Float: 13.6~13.8 V/77° F(25°C)	
	Cycle:14.4~14.7 V/77°F(25°C) Max. Current: 25A	

SPECIFICATION

Nominal voltage	12V
Number of cell	6
Length(mm/inch)	328/12.9
Width(mm/inch)	171/6.74
Height(mm/inch)	214/8.43
Total Height(mm/inch)	220/8.66
Approx. Weight(kg/lbs)	30.5/67.2

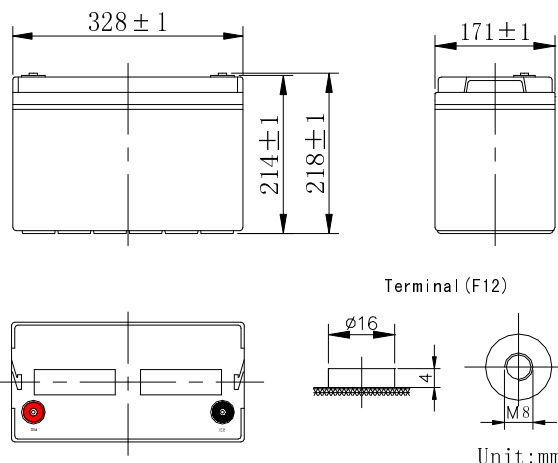

Discharge Constant Current (Amperes at 77° F 25 °C)

End Point Volts/Cell	5min	10min	15min	30min	1h	3h	5h	10h	20h
1.60V	323	221	182	103	63.5	26.5	18.2	10.3	5.40
1.65V	296	207	173	99.0	62.5	26.0	18.0	10.3	5.40
1.70V	270	192	164	96.0	61.5	25.5	17.7	10.2	5.35
1.75V	242	179	153	93.0	60.5	24.9	17.4	10.1	5.30
1.80V	214	164	143	91.0	59.5	24.3	17.0	10.0	5.20

Discharge Constant Power (watts at 77° F 25 °C)

End Point Volts/Cell	5min	10min	15min	30min	45min	1h	2h	3h	5h
1.60V	556	392	320	194	144	124	70.3	49.6	34.7
1.65V	517	372	315	188	140	122	69.1	49.0	34.5
1.70V	478	353	305	183	137	121	67.8	48.5	34.2
1.75V	441	334	294	177	134	117	66.6	47.9	34.0
1.80V	401	312	284	171	131	114	65.9	47.1	33.7

(Note)The above characteristics data are average values obtained Within three charge/discharge cycles not the minimum values.

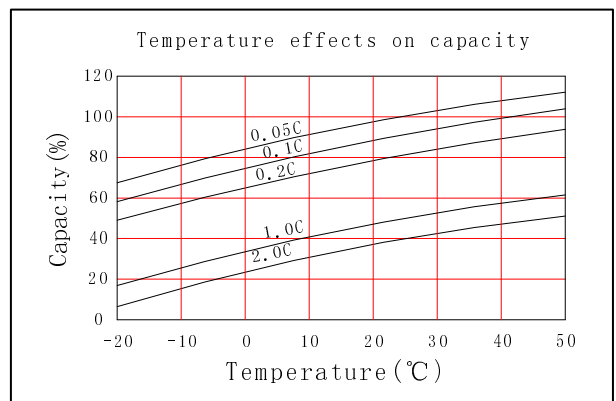
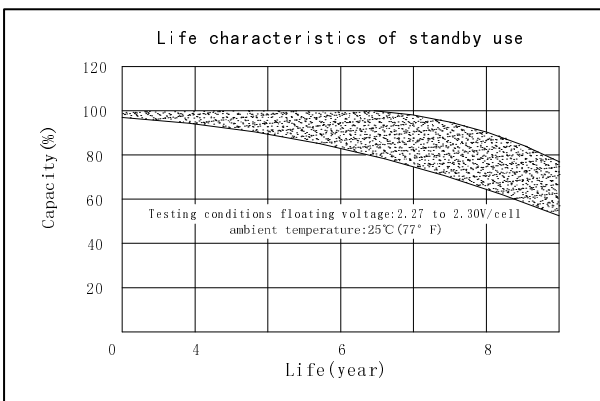
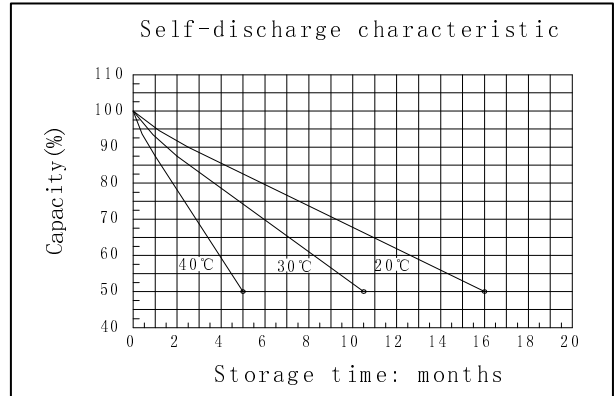
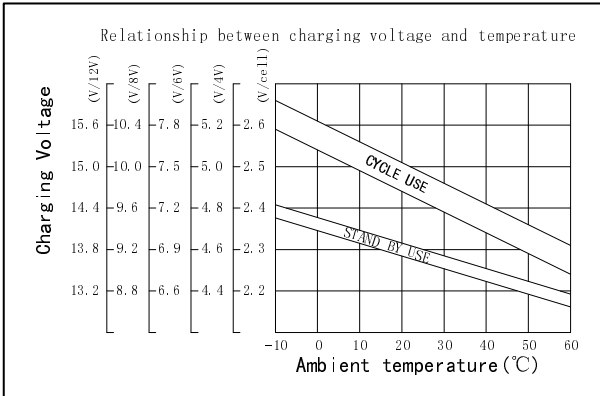
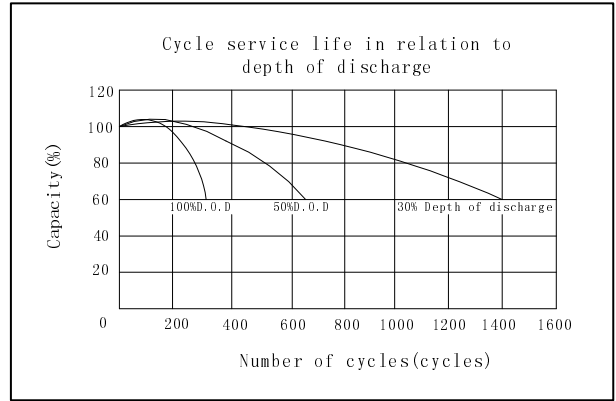
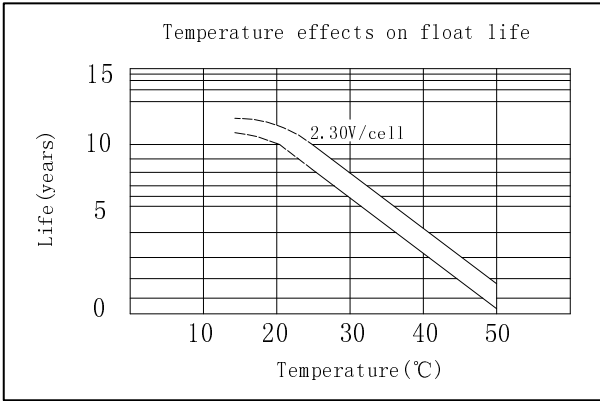
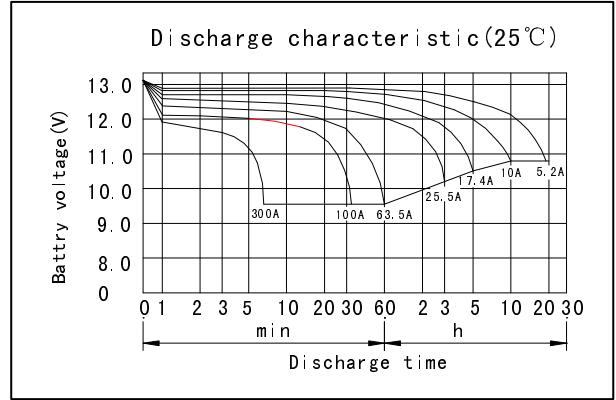
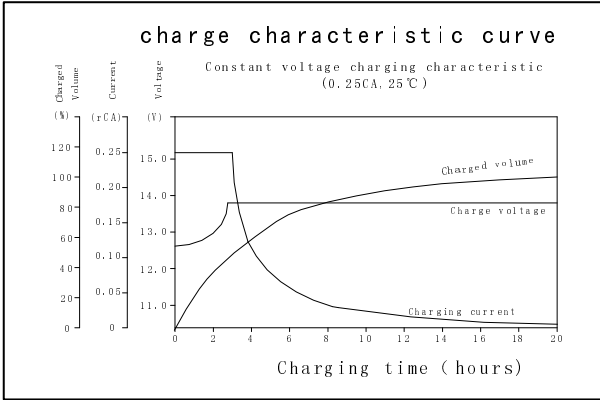

GREAT POWER BATTERY TECHNOLOGY CO.,LTD

Address: Longguan 1st Road, LongHua Town, BaoAn District, Shenzhen, China.

TEL: 86-755-2900 8403 Fax: 86-755-3386 3366

Email: info@greatpowerbattery.com Http:// www.greatpowerbattery.com

